

# Zenolite®

Transform Spaces with Living Colour

[zenolite.com](http://zenolite.com)

**EGR**  
DECOR

Time	Flight	Destination	Status
3:00 PM	BA-844	Barcelona	On Time
3:05 PM	LX-355	Zürich	Delayed
4:25 PM	AZ-477	Paris	On Time
4:29 PM	BA-55	London	On Time
5:12 PM	LX-974	Taipei	On Time
5:24 PM	UA-544	New York	On Time
5:37 PM	AA-43	San Francisco	On Time
5:45 PM	IB-544	Buenos Aires	On Time
3:00 PM	IB-844	Barcelona	On Time
3:05 PM	LX-355	Zürich	Delayed
4:25 PM	AZ-477	Paris	On Time
4:29 PM	BA-55	London	On Time
5:12 PM	LX-974	Taipei	On Time
5:24 PM	UA-544	New York	On Time
5:37 PM	AA-43	San Francisco	On Time
5:45 PM	IB-544	Buenos Aires	On Time
3:00 PM	IB-844	Barcelona	On Time
3:05 PM	LX-355	Zürich	Delayed
4:25 PM	AZ-477	Paris	On Time
4:29 PM	BA-55	London	On Time
5:12 PM	LX-974	Taipei	On Time
5:24 PM	UA-544	New York	On Time
5:37 PM	AA-43	San Francisco	On Time
5:45 PM	IB-544	Buenos Aires	On Time
3:00 PM	IB-844	Barcelona	On Time
3:05 PM	LX-355	Zürich	Delayed
4:25 PM	AZ-477	Paris	On Time
4:29 PM	BA-55	London	On Time



# Zenolite<sup>®</sup>

A sophisticated panel solution that transforms any room

Designed and manufactured in Australia and exported globally, Zenolite is an ideal solution for both residential and commercial applications.

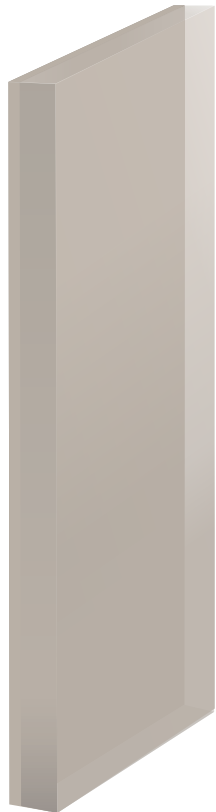

Zenolite is manufactured from two layers of acrylic, co-extruded into a single sheet. A vibrant colour layer is capped with a crystal clear top layer to create a panel of incredible depth, gloss and clarity.

- Lightweight and easy to handle, Zenolite can be installed rapidly over new or existing wall finishes.
- Zenolite can be fabricated on-site with standard woodworking tools, and installed using double-sided tape and neutral cure silicone.
- Zenolite's surface is resistant to mould and bacteria, therefore making it easy to clean and maintain.



100% Australian  
Owned and Made



Right: Zenolite Glacier, Moleskin and Snowy Mountain.



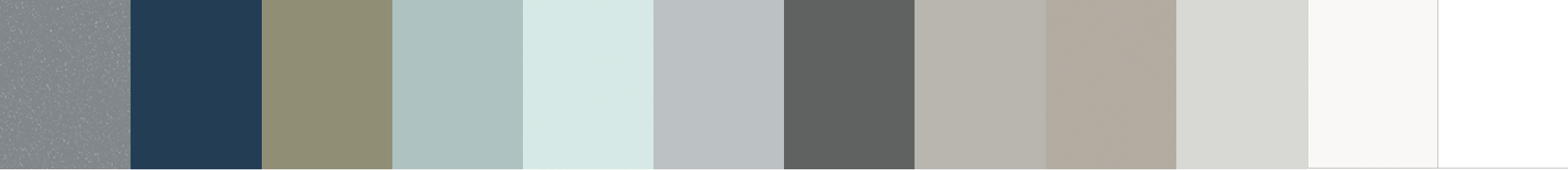

## Creative Applications

Zenolite panels unique properties offer designers the opportunity to create exciting and highly functional spaces.

Below: Zenolite Arctic splashback in a caravan application.

## Inspirational Colours

The Zenolite colour palette has been carefully crafted to offer both grounded and inspirational options for the designer.

The colours will work in harmony or contrast with many natural and industrial finishes.

Designers can choose to create a sense of calm or drama by exploring the tones of the Zenolite palette.











## Retail and Commercial

The Zenolite on trend colour palette, flawless finish and design flexibility will enhance any retail environment. Retailers can take the advantage to define their product offering with a crisp and clean Zenolite canvas.

Zenolite surfaces will satisfy the needs of the most prestigious of commercial spaces with consistent visual outcomes, rapid installation, ease of maintenance and are very cost effective.



Above: Zenolite Titan, Arctic and Regatta.

Left: Zenolite Moleskin, Regatta, Macchiato, Sago, Tusk and Khaki.

# Zenolite Information and Colour Range

Panel Sizes	Arctic	Tusk	Malt	Sago	Moleskin	Macchiato	Snowy Mountain	Glacier	Pale Eucalypt	Khaki	Regatta	Titan
2440 x 1220 x 4 mm	●	●	●	●	●	●	●	●	●	●	●	●
2440 x 1220 x 6 mm	●			●				●				
2600 x 760 x 4 mm	●			●				●				●
3050 x 1220 x 4 mm	●	●	●	●	●	●	●	●	●	●	●	●
3050 x 1220 x 6 mm	●											

## Savings

**Time and Cost:** Choosing Zenolite over tiles or glass saves time and money due to the large panel size, rapid installation, ability to be fabricated on site and significantly less jointing required.

**Freight and Packaging:** Costs are reduced because of Zenolite's low weight, allowing for more shipping and transport options. Less energy is used for cartage, plus it's easier to handle and move around with less chance of breakage.

**Maintenance:** Being completely inert with an impervious surface, bacteria and mould do not permeate the sheet. Surface contaminants are simply wiped away with mild soap and water - delivering a significant saving in labour and chemicals use over the life of the installation. Zenolite panels and sheets carry a 10 year indoor UV warranty.

## Fire Properties

Australia and NZ  
AS/NZS 1530.3 and AS 3837  
Achieved Group 4.

Building specifiers should always consult with qualified building professionals to ensure that the material is suitable and compliant for the chosen application as per local building code requirements.

## Colour

The colour layer is designed to be very consistent with high opacity to cover the underlying wall finish. The coloured and clear layers are permanently fused during the extrusion process for maximum performance and longevity.

## Workability and Installation

Zenolite can easily be worked on in the workshop or on-site due to its light weight and durability. It can be cut, sawn, drilled and finished using standard woodworking tools. Compared to tiles and glass, installation is exceptionally fast requiring only double sided tape and neutral cure silicone.

For full details please refer to the Zenolite Technical Guide at - [zenolite.com](http://zenolite.com). *Note - Zenolite thermal movement is 0.7mm / 1000mm / 10°C*

## Environment

Zenolite is designed to have as minimal impact on the environment and is wholly manufactured under the EGR Environmental Management System, which has been independently accredited to ISO14001. The manufacturing process does not release any harmful emissions to air, land or water. Zenolite is hygienic and does not promote bacterial growth or transmission making it ideal for food outlets, high traffic areas and public spaces.

## Edge Finishing

There are many ways to edge finish Zenolite panels. Sand or polish for a clean glass like appearance or conceal and protect the edges with matching anodized aluminium profiles.

## Chemical Resistance

Zenolite is an inert and very stable polymer and is resistant to the following substances:

Kerosene, Mineral Turpentine, lemon juice, Vinegar, Coffee, Soaps and most mild household cleaners.

Zenolite should not be exposed to the following substances:

Acetone, Methylated Spirits, Glass Cleaners, Aggressive solvents such as MEK or Toluene, Abrasive Cleaners

## Warranty

Zenolite sheet is covered by a 10 year indoor warranty for use in vertical applications only.

Due to the nature of the printing process, the colours and images depicted throughout this brochure may vary compared to the actual finished products' colour. Images and colours are to be used as a guide only.

Colour Range

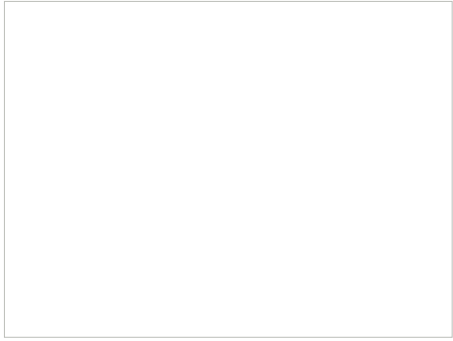

Arctic

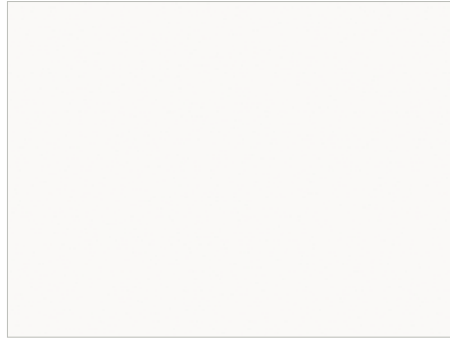

Tusk

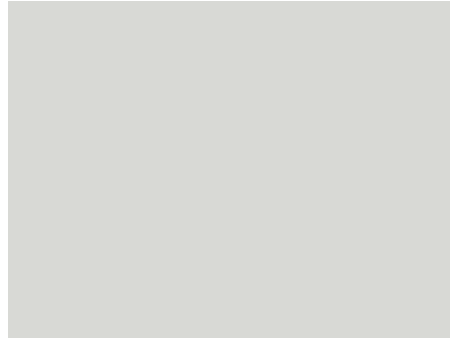

Malt



Sago



Moleskin



Macchiato



Snowy Mountain

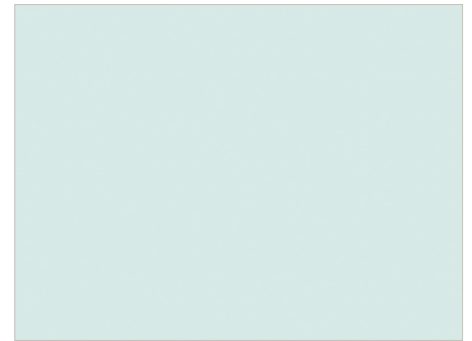

Glacier



Pale Eucalypt



Khaki



Regatta

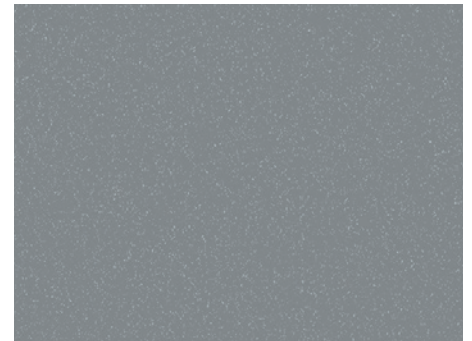

Titan (Metallic)

# EGR DECOR

## Redefining Decorative Solutions

Drawing on a rich and diverse 47-year heritage in the design, manufacture, and marketing of leading-edge products for Australian and international markets, EGR Decor offers designers, fabricators and homeowners a stunning collection of premium vertical surface materials.

**EGR**  
**DECOR**

Zenolite®

### Edge finishing and joining

Zenolite can be finished using a variety of aluminium edge extrusions. There are four profiles each supplied in 2500mm lengths.

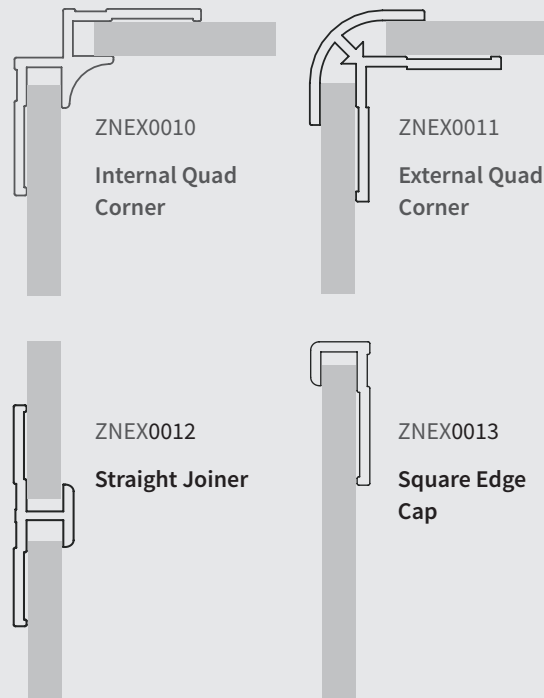

### Joint Design Options

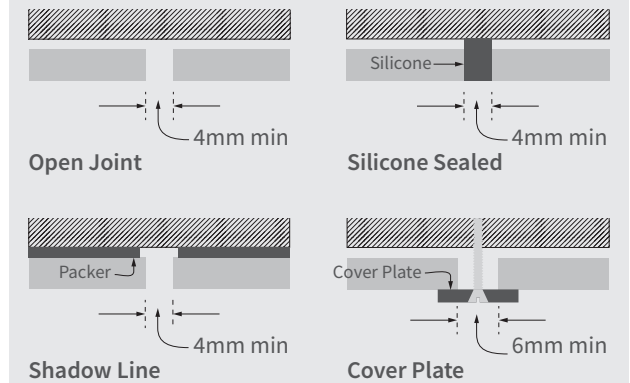

### Warnings

Zenolite is designed for interior, vertical use only.

Zenolite panels are thermoplastic and will expand and contract with temperature and therefore will perform best in temperature controlled environments with recommended expansion gaps.

Avoid use in areas exposed to intense direct sunlight such as adjacent to skylights or large unshaded windows.

For specific installation recommendations contact our technical service team at [zenolite.com](http://zenolite.com)

PROUDLY DISTRIBUTED BY:



**Durable. Contemporary. High-quality.**

## EGR Decor

40 Machinery St, Darra, Brisbane  
Queensland 4076, Australia

[www.zenolite.com](http://www.zenolite.com)

[info@zenolite.com](mailto:info@zenolite.com)

1800 347 347



1. EGR expressly disclaims any representations or warranties of any kind, whether express or implied, as to the accuracy, currency, completeness and/or the merchantability or fitness for a particular purpose of any information contained in or provided via this documentation and/or any service or product described or promoted in this document. 2. It is the customer's responsibility to thoroughly examine the product using a qualified person, to determine whether it is suitable for the application it was purchased for. 3. The receiver of our products is fully responsible to check and to take into account possible third party's patent rights, as well as the existing laws in the country of installation prior to installing our product. 4. No liability may be derived from these images or statements nor from our free technical advice. 5. EGR reserves the right to change, add or remove colours or product without notice. 6. EGR Decor and EGR are registered trademarks. 7. Images and colours should be used as a guide only. 8. 10 Year Indoor Warranty: The EGR Decor warranties cover faulty materials for the periods specified on the relevant product warranty documents. The EGR Decor warranties commence from the date of sale by EGR, they are not transferable and are subject to the terms, conditions and exclusions contained within those warranties.

© Copyright 2020 / Patent Pending Oakmoore Pty Ltd trading as EGR. 342-080620 V9 280820